

---

# INSTRUCTION MANUAL

---

**EMCO**

**147 A**

SIGNAL  
TRACER

---

**EMCO**

---

283 Malta Street, Brooklyn, N. Y. 11207

# general description

## GENERAL DESCRIPTION

The EICO Model 147A Signal Tracer is a deluxe instrument crammed with unsurpassed testing facilities and conveniences for efficient, profitable servicing of am, fm and tv receivers. Not only have valuable auxillary testing facilities been incorporated, such as a noise locator circuit and a calibrated wattmeter, but careful attention has been given to the basic requirements of good audio quality and high sensitivity. Features, applications, and specifications are given below

## FEATURES AND APPLICATIONS

1. Two input channels: high-gain RF and low-gain audio. RF channel gain more than adequate for tracing up to receiver input.
2. Both visual and aural signal monitors (eye tube and speaker). Visual monitor permits easier estimation of signal strength and gain-per-stage.
3. Shielded RF crystal demodulator and direct probes provided. Individual panel receptacles provided for easy change-over from RF to audio tracing or visa versa.
4. Valuable noise locator circuit ferrets out noisy controls, resistors, capacitors, coils, transformers, cold solder joints, etc.
5. Calibrated wattmeter affords rapid preliminary check of power consumption in equipment under test. Detects B+ short, intermittent filament circuit, defective filter or bypass capacitors, etc. Fuse for safety.
6. May be connected as substitute speaker, amplifier, or output transformer.
7. Output for VTVM or oscilloscope.
8. Transformer operated for isolation and safety.

## SPECIFICATIONS

Tube & Diode Complement: 1- 12AX7 dual triode as voltage amplifiers, 1- 6AQ5 as beam power amplifier, 1- 1629 electron-ray indicator, 1- 6X4 as full-wave rectifier, 1- 1N48 germanium diode as wattmeter rectifier.

Power Requirements: 105-125 volts ac, 50/60 cycles.

Size: 8" high, 10" wide, 4 3/4" deep.

Shipping Weight: 11 pounds

## CIRCUIT DESCRIPTION

The Model 147A Signal Tracer is basically a transformer-operated three-stage, high gain audio amplifier. A 1629 eye tube is connected to the grid of the third stage to provide visual monitoring of the signal level while a speaker is coupled to the output for aural monitoring. The first stage is intended primarily to preamplify the audio stripped from the a-m broadcast or test oscillator signal by the RF crystal demodulator probe. The last two stages form a low-gain audio amplifier provided with a separate input and a direct audio probe. In this way, normal audio circuit exploration can be carried on with the possibility of amplitude or rectification distortion minimized and the lowest possible hum and noise level. As the gain control is in the grid circuit of the second stage, it is effective when either channel is used. Additional test facilities provided are a built-in calibrated wattmeter, a noise locator circuit, and substitute test speaker, amplifier, and output transformer.

One triode section of the 12AX7 tube (V1A) is the pre-amplifier or first stage; the other triode section of the 12AX7 tube (V1B) is the second amplifier and is coupled conventionally to the 6AQ5 beam power output tube V2, which is the third amplifier. A 1N48 germanium diode provides the retification required for the wattmeter circuit. The primary of the output transformer connected to the last stage is tapped so that substitution may be made for the output transformer in either a single-ended or push-pull amplifier.

A panel switch (INPUT SELECTOR S1) in the grid circuit of the V1B tube section permits this grid to be connected in the following ways: a) to the plate of the V1A triode preamplifier for RF signal tracing; b) to the AUDIO panel connector via blocking capacitor C2 for low-gain audio signal tracing; c) same as (b) but approximately 130 VDC placed on AUDIO panel connector for application to suspected components in NOISE testing.

Another panel switch, OUTPUT SELECTOR S2, connects the eye tube for either tracing or wattmeter use (via section S2A) and for tracing or the various substitution tests (via section S2B). Section S2B also switches AC supply power on and off. As the power must be off when the instrument is used as a substitution output transformer, AC OFF and TEST OUT. XFMR are the same position of the switch. At the TRACE and TEST AMP-TEST SPKR. positions, the power is on as is obviously required for the TRACE and TEST AMPLIFIER functions (although not for the TEST SPKR. function).

The transformer-operated, full wave rectifier power supply utilizes a quadruple electrolytic filter capacitor to provide maximum filtering for hum-free operation. The hum level is further reduced by a hum-balancing control. As a result

of these important measures toward hum reduction, inherent hum is extremely low and the hum heard while using the high gain (RF) input can be classified as grid hum. As the RF probe circuit actually constitutes an extension of the V1A triode grid circuit, this is understandable.

It is only natural that there be some hum when the high gain input channel is used with the gain control set at

## operation

---

### GENERAL

Signal tracing a receiver consists of following or tracing a broadcast signal or the radio-modulated output of an r-f signal generator through the various stages of a receiver by connecting an indicating device, such as a signal tracer, first to the input and then to the output of each succeeding stage. The trouble is thereby located in the stage between the point at which the desired signal disappears or is not of proper strength, or an undesired signal (such as hum, noise, or oscillation) appears, and the last previous point at which no trouble was encountered. Once the defective stage is located, control and operating voltage checks are made, which, if necessary, are followed by d-c resistance checks and special component tests such as tube tests, value and leakage checks of capacitors, and noise locator tests. These tests allow the final determination of the defect in the stage which signal tracing has localized as the source of the trouble.

A good r-f signal generator is highly desirable for signal tracing (especially in weak signal areas) since it provides a steady signal of controlled strength and frequency as well as constant audio-frequency modulation. This is particularly important in estimating signal level and gain-per-stage with the electron-ray indicator or an external VTVM or 'scope. For detecting distortion, however, it is preferable to employ a broadcast signal, since distortion in music or speech can be detected much more readily by ear than distortion in a single-frequency tone. Of course, if distortion is to be detected visually with a 'scope, the single-frequency modulated output of a signal generator must be used, as distortion would be impossible to detect visually in the varying complex tone of music or speech.

In checking f-m sets or the sound section of a tv receiver, it is not necessary to use a frequency-modulated signal except in the a-f section. An a-m carrier can be traced using the RF channel as far as the ratio detector; or if a phase discriminator is used, it can be detected as an d-c voltage in the output circuit of the discriminator. To determine proper operation of the a-f stage, an a-m signal can be fed to the receiver at the antenna input terminals. Sufficient audio signal will get through to provide a quality check. As with a-m receivers, distortion is checked by listening to broadcast music or speech.

maximum. While a triode is used as the input stage, which is desirable, a certain amount of sporadic microphonic operation is normal and to be expected. Almost any tube used in this application would exhibit this condition to some extent. However, it should be possible to use maximum gain without meeting a continuous microphonic condition.

Obviously, all-wave receivers can be checked on the broadcast band as well as an ordinary a-m receiver. If the defect is encountered on all bands, it will be revealed by signal tracing on the broadcast band. If the defect is encountered on one band and not on the others, then the trouble is in the r-f, mixer, or oscillator sections since the rest of the receiver is the same on all bands. If the oscillator and mixer sections check properly, then the trouble is localized to the r-f section. It is recommended that the r-f signal generator be set at 600 kc for testing standard a-m broadcast and all-wave receivers since the capacity of the ganged tuning capacitor in the receiver is high when set to tune in this frequency. As a result, the additional shunt capacity introduced by connecting the test probe to the circuit will not cause appreciable detuning.

### RF SIGNAL TRACING

Connect the RF probe to the panel connector marked RF INPUT. Set the INPUT SELECTOR at RF. Set the OUTPUT SELECTOR at TRACE if the aural (speaker) monitor is desired or at TEST SPKR-TEST AMPL if it is more convenient to work with the speaker off and a VTVM or 'scope is connected to the VTVM-SCOPE jack.

The eye tube indication is the size of the shadow angle (dark sector). The larger the signal voltage applied to the grid of the eye tube, the narrower the angle; the smaller the signal voltage, the wider the shadow angle. Two factors control the magnitude of the signal voltage applied to the eye tube grid and therefore the size of the shadow angle. One is the strength of the signal at the point to which the probe is touched; the other is the setting of the GAIN control. To maintain a constant shadow angle of any desired magnitude that you may choose as a reference level, normally you must reduce the GAIN control setting (turn it counter-clockwise) progressively as you trace the signal thru the receiver point-by-point starting from the antenna input terminals. With practice, you will get to know whether the gain of a particular stage is approximately normal by how much the GAIN control setting needs to be decreased in order to maintain a constant shadow angle as you move the test probe from the input to the output of the stage. Checking for normal gain-per-stage by

this method should eventually gain the preference of the operator for rapid service work. For an actual numerical check of gain-per-stage, a scope or vtvm should be connected to the panel terminals provided. The GAIN control can be used to establish any desired reference level. The signal tracer will provide more than enough gain to permit easily observable differences in readings or deflections.

Let us take the case of the weak receiver as a typical servicing problem, and outline the signal tracing method of locating the cause of the trouble. It is assumed that routine checks of tubes, of voltages on tube elements, of line voltage, and of adequacy of antenna for receiver and location, as well as a wattmeter test, have not revealed the reason for weak signals, and that therefore signal tracing is indicated. As the receiver is operative, either tune the receiver to a local station, preferably around 600 kc, or connect a signal generator between the antenna and ground terminals and feed a 600 kc audio-modulated signal to the operating receiver. Turn down the volume control of the receiver as it is the sound emanating from the signal tracer speaker which is of interest during the tests, not the sound from the receiver speaker. Connect the ground lead of the RF probe to B minus or ground of the receiver under test and apply the test probe directly to the antenna terminal or to the antenna loop. Turn up the signal tracer gain control until sufficient indication of the signal level is obtained. The test probe can then be moved along the normal signal path point-by-point; to the grid and then the plate of the RF stage, if one is present; to the grid and then the plate of the mixer or converter tube; to the grid and then the plate of the first IF tube; and then to the grid and plate of any other IF tubes, in order, and on into the detector stage. As was discussed previously, the operator will with experience come to know whether or not normal stage gain is being obtained in each particular stage.

It should be noted that the input capacity of the RF probe may in some cases be sufficiently large to cause a slight detuning effect when touched to tuned circuits and may induce oscillation. If this should occur, it would generally be wiser to pass on to the next test point rather than to conclude that the receiver is defective in this respect. If the receiver gives good signal indication at the next test point, in all likelihood the effect just described is responsible and the receiver is operating properly.

## AUDIO SIGNAL TRACING

To trace the signal through the audio stages following the detector in the receiver circuit, neither the RF probe nor high gain is required. To provide the best fidelity of reproduction and the lowest possible hum and noise level, a shielded direct probe and the low gain audio channel are used. The audio probe is plugged into the AUDIO INPUT pin jacks, and the INPUT SELECTOR set at AUDIO to connect to the low gain amplifier. Here again, the OUTPUT SELECTOR is set according to the desired use of the eye tube and the speaker. Note that all output transformers in receivers are of the step-down type to match the rela-

tively high impedance of the output tube plate circuit to the low impedance of the speaker. Naturally, therefore a sharp drop in signal voltage will be observed when the probe is moved from the primary winding of the output transformer to the secondary winding. Elsewhere in the a section, of course, the gain increases as the probe is moved from the detector toward the speaker.

It is important to realize that the presence of signal at particular point may indicate improper operation just as much as the absence of signal at some other point. For example, it is common practice to employ a large capacitor to bypass the bias resistor in the cathode circuit of the output stage. If signal voltage is picked up at the cathode obviously the bypass capacitor is not performing its function and is probably open.

## WATTMETER

The wattmeter circuit is extremely valuable for servicing tv, a-m & f-m radio, P. A. equipment, or any electronic devices operating from the a-c line and not drawing more than 500 watts normally.

To use the instrument as a wattmeter, set the OUTPUT SELECTOR at WATTMETER. The INPUT SELECTOR may be set at any position, and the GAIN control should be turned maximum-counter-clockwise as the amplifiers are not employed in this function. After preliminary resistance checks of the equipment have been made to ensure that it is safe to apply power to the receiver and that a short does not exist which would cause so much current to be drawn through the wattmeter as to cause the fuse to blow, plug the line cord of the equipment under test into the WATTMETER LOAD receptacle on the panel. Then turn on the receiver and allow a short warm-up period for the receiver to reach normal operating conditions. Adjust the WATTMETER control until the shadow angle on the eye tube just closes with no overlapping of the edges of the bright sector and read the power consumption in watts directly from the calibrated dial. The eye will close even at zero on the dial, unless the drain is at least 35 watts. This is not a disadvantage in checking the great many receivers drawing 30 watts or so normally, since a short will bring the power consumption to well over 35 watts and therefore unquestionably show up in this test. Also, at zero on the dial a 30 watt receiver will produce a considerably narrowed shadow angle from the maximum which is sufficient indication of normal loading.

The wattmeter reading can then be compared with the normal power consumption of the receiver which is usually given on the chassis label. As the wattmeter circuit is responsive only to the current drawn and the dial calibrations are drawn on the basis of the average U. S. line voltage of 117 vac, obviously the accuracy of the reading will depend on the actual line voltage as well as the actual power factor of the equipment under test. In general, therefore, it would not be reasonable to expect accuracy greater than 10%.

In the case of a transformer-operated receiver as an example, the wattmeter indications would be interpreted as follows. A preliminary wattmeter check showing normal power consumption would indicate that at least the power transformer is o.k. and if there is power supply trouble at all, it may be found to lie in a weak rectifier, weak filter capacitor, or at some point further on. If, however, the power drain is abnormally high, the next step would be to remove the rectifier tube and observe whether or not the power drain falls to approximately normal. If it does, then a defective filter or bypass capacitor is indicated, or possibly a short filter choke or bleeder, or a gassy rectifier. (To check a filter capacitor which is suspected, just disconnect one end from the circuit and observe whether or not the power consumption drops noticeably. If it does, replace the filter capacitor.) If abnormally high power consumption is not reduced by removing the rectifier, then a short in the power transformer is indicated.

To establish the cause of low power consumption, short the B plus circuit to ground momentarily at the filter capacitor output and note the power consumption while doing so. Abnormally high power consumption would be normal under this circumstance and low consumption would point to a weak or gassy rectifier or possibly a defect in the power transformer.

**WATTMETER MAINTENANCE NOTE:** Failure of line voltage to appear at the WATTMETER LOAD receptacle (with OUTPUT SELECTOR set at WATTMETER) indicates that in all probability the wattmeter circuit fuse (5A), located on the underside of the chassis, has blown due to an overload.

## NOISE LOCATOR

The noise locator circuit is used to locate noisy and intermittent components. A filtered dc voltage taken from the power supply is applied via the audio probe to the suspected component and the effect amplified so that it is heard through the speaker and observed on the eye. The ground clip of the audio probe, of course provides the necessary ground return circuit. The applied voltage at no load is about 130 vdc ( $\pm 20\%$ ), but there is no danger of damaging receiver components since the short circuit current is about 1 ma. Some care should be taken in handling the probe although the shock that can result from careless handling is relatively harmless.

Noise locator tests are made only when the receiver under test is completely disconnected from the a-c line. The instrument is set up for noise testing by setting the INPUT SELECTOR at NOISE, the GAIN control at near maximum clockwise rotation, and the OUTPUT SELECTOR at TRACE. The following is a typical example of noise location procedure, taking the plate circuit of the IF stage as an example: Connect the audio probe ground clip to the B plus supply point and apply the audio probe to the plate of the

IF tube. If a sharp clean click is heard at the instant of contact, with no frying, crackling, or buzzing sound afterwards as the probe is held at the test point, it indicates that there are no noisy or intermittent components in the path from the plate of the IF tube to the B plus point to which the ground clip is connected. If frying, crackling, or buzzing is heard, then there is a noisy or intermittent component in the path. In the latter case, the obvious procedure is to move the test probe down toward the B plus point, checking at each junction between two components in the path. In all likelihood, the noise indication will disappear at some point along the path. When this occurs, return the test probe to the last point at which the noise indication appeared, and check the component between this point and the point at which the noise indication disappeared for a possible defect.

The noise locator test will show up noisy and intermittent resistors, volume and tone controls, capacitors, and cold solder joints. The part under test should be jiggled or prodded in order to determine whether or not an intermittent or noisy condition exists.

## PANEL CONNECTIONS

For the utmost flexibility and convenience, seven pin jacks are provided on the panel for connection of the instrument as a substitute amplifier, substitute speaker, substitute output transformer, and for connection of the signal tracer output to a vtvm or scope. Specific instructions follow for setting up and connecting to the instrument for each function.

**SUBSTITUTE SPEAKER:** With the OUTPUT SELECTOR set at TEST SPKR-TEST AMPL, the voice coil terminals of the internal speaker are available at the TEST SPKR and GND pin jacks.

**SUBSTITUTE AMPLIFIER:** With the OUTPUT SELECTOR set at TEST SPKR-TEST AMPL, connections to the output transformer secondary of the tracer amplifier are available at the TEST AMPL and GND pin jacks.

**SUBSTITUTE OUTPUT TRANSFORMER (PLUS SPEAKER):** With the OUTPUT SELECTOR set at AC OFF-TEST OUT. XFMR, connect the plate lead of single-ended power amplifiers to either P pin jack and the B+ lead to the B+ pin jack. For push-pull amplifiers, connect one power amplifier plate lead to one P pin jack and the other plate lead to the other P pin jack; connect the B+ lead to the B+ pin jack. The OUTPUT SELECTOR should be turned to AC OFF-TEST OUT. XFMR before connections to the output transformer pin jacks are made (there is a dangerously high B+ voltage on the B+ pin jack when the instrument is on). The OUTPUT SELECTOR should not be moved from the OFF position during the test or before unmaking the pin jack connections at the conclusion of the test.

## SERVICE

If trouble develops in your instrument which you can not remedy yourself, write to our service department listing all possible indications that might be helpful. If desired you may return the instrument to our factory where it will be placed in operating condition for \$5.00 plus the cost of parts replaced due to their being damaged in the course of construction. NOTE: Before returning this unit, be sure all parts are securely mounted. Attach a tag to the instrument, giving your home address and the trouble with

the unit. Pack very carefully in a rugged container, using sufficient packing material (cotton, shredded newspaper, or excelsior), to make the unit completely immovable within the container. The original shipping carton is satisfactory, providing the original inserts are used or sufficient packing material inserted to keep the instrument immovable. Ship by prepaid Railway Express, if possible, to Electronic Instrument Co., Inc., 33-00 Northern Blvd., Long Island City 1, New York. Return shipment will be made by express collect. Note that a carrier cannot be held liable for damages in transit if packing IN HIS OPINION, is insufficient.

## VOLTAGE AND RESISTANCE CHART

TUBE	PIN#	VOLTS	OHMS (UNIT OFF)
<u>ECC83/12AX7</u> V1	1	75VDC	270K $\Omega$
	2	0	0
	3	0.9VDC	2.2K $\Omega$
	4 & 5	6.3 VAC	0
	6	100VDC	330K $\Omega$
	7	-1 VDC (approx.)	10 Meg $\Omega$
	8	0	0
	9	0	0
	<u>6AQ5</u> V2	1	0
2		13VDC	330 $\Omega$
3		0	0
4		6.3 VAC	0
5		260VDC	1.15K $\Omega$
6		265VDC	1K $\Omega$
7		0	470K $\Omega$
<u>6X4</u> V3	1	270 VAC	250 $\Omega$
	2	-	-
	3	0	0
	4	6.3 VAC	0
	5	-	-
	6	270 VAC	250 $\Omega$
	7	310 VDC	100K $\Omega$ or greater
<u>1629</u> V4	1	-	-
	2	6.3 VAC	0
	3	18VDC	1 Meg $\Omega$
	4	260 VDC	1K $\Omega$
	5	-0.8 VDC	500K $\Omega$
	6	-	-
	7	6.3 VAC	0
	8	0	0

Voltages given are operating voltages measured with no signal. Resistances are measured to ground with unit off. Cathode of rectifier (pin 7 of V3) shorted to ground during all resistance measurements except when measuring resistance from pin 7 of V3 to ground. CONTROL SETTINGS: GAIN at minimum, INPUT SEL. to RF, OUTPUT SEL. to TEST SPKR., WATTS to 0. Voltage measurements are made with a VTVM or 20,000  $\Omega$ /V VOM. Operating line voltage at which voltage measurements are made is 117 VAC, 60 cps. NOTE: ALL VOLTAGE & RESISTANCE VALUES MAY VARY NORMALLY BY  $\pm 15\%$ .

## PARTS LIST

<u>Stock #</u>	<u>Sym.</u>	<u>Description</u>	<u>Am't.</u>	<u>Stock #</u>	<u>Description</u>	<u>Am't.</u>
22513	C1	cap., disc., .005mfd (5K or 5000mmf) ±10%	1	40007	nut, hex, #4-40	6
22517	C2,3,4	cap., disc., .025mfd (25K or 2500mmf) ±10%	3	41000	screw, #6-32 x 1/4	12
24003	C5	cap., elec., 2x 20/450V - 2x 10/350V	1	41001	screw, #10-24 x 3/8	2
20044	C6	cap., molded, .25mfd - 400V	1	41014	screw, #6-32 x 3/8	2
95000	CR1,2	rectifier, 1N48	2	41016	screw, #4-40 x 1/4	6
91003	F1	fuse, 5A, slo-blo	1	41035	screw, #6 P.K.	9
50001	J2,7,8,9,10	jack, pin, black	5	42000	washer, 3/8 lock	6
50000	J1,4,5,6	jack, pin, red	4	42001	washer, 3/8 flat	4
50002	J3	mic. connector male	1	42002	washer, #6 lock	14
50009	J11	receptacle, AC	1	42007	washer, #4 lock	6
10402	R1	res., 10MΩ (brown, black, blue, silver) 1/2W, ±10%	1	42012	washer, star (for pin jacks)	9
10431	R2,8,20	res., 470KΩ (yellow, violet, yellow, silver) 1/2W, ±10%	3	42019	washer, rubber	1
10410	R3	res., 100KΩ (brown, black, yellow, silver) 1/2W, ±10%	1	43000	lug, #6 ground	1
10417	R4,7	res., 220KΩ (red, red, yellow, silver) 1/2W, ±10%	2	43001	lug, 3/8 pot ground	1
18043	R5	pot., 500KΩ audio taper	1	46000	grommet, 3/8 rubber	1
10423	R6	res., 2.2KΩ (red, red, red, silver) 1/2W, ±10%	1	46005	feet, rubber	4
10862	R9	res., 330Ω (orange, orange, brown, silver) 1W, ±10%	1	47001	spring	1
10407	R10,16, 17,19	res., 1MΩ (brown, black, green, silver) 1/2W, ±10%	4	51000	connector, female	1
10436	R11	res., 47Ω (yellow, violet, black, silver) 1/2W, ±10%	1	51004	tip, pin	2
10409	R12	res., 560KΩ (green, blue, yellow, silver) 1/2W, ±10%	1	51502	clip, crocodile	2
14501	R13	res., 1KΩ, 5W, ±10%	1	53006	knob, round bar	4
10428	R14	res., 47KΩ (yellow, violet, orange, silver) 1/2W, ±10%	1	54507	board, probe	1
10422	R15	res., 68KΩ (blue, grey, orange, silver) 1/2W, ±10%	1	55301	grill, speaker	1
16004	R18	pot., 50KΩ, linear	1	55500	probe, red	1
60053	S1	switch, input selector	1	57000	line cord	1
60054	S2	switch, output selector	1	58004	wire, hook-up	length
55000	SP1	speaker	1	58300	spaghetti	length
32009	T1	transformer, output	1	58401	cable, mic.	length
30023	T2	transformer, power	1	58403	cable, grey	length
32003	T3	transformer, current	1	58501	wire, bare, #22	length
54004	TB1,2	terminal strip, 2 post with ground	2	58502	braid, flat	length
54013	TB3,4,5	terminal strip, 1 post left with ground	3	80056	panel	1
90034	V1	tube, 12AX7	1	81055	eye bracket	1
90047	V2	tube, 6AQ5	1	81122	chassis	1
90036	V3	tube, 6X4	1	87000	handle	1
90015	V4	tube, 1629	1	88021	cabinet	1
97025	XV1	socket, 9 pin min. bottom mount	1	89511	probe, nosepiece	1
97024	XV2,3	socket, 7 pin min. bottom mount	2	89512	probe, tip	1
97013	XV4	socket, octal, molded	1	89524	probe, shell	1
40000		nut, hex #6-32	14	66062	instruction manual (wired)	1
40001		nut, hex 3/8-32	4	66311	instruction manual (kit)	1

NOTE: When ordering replacement parts, please include all of the following information: 1) stock number and description given in parts list; 2) quantity; 3) model number of instrument; 4) serial number of instrument (on panel). This information will expedite the processing of your order and insure your receiving the correct replacement parts.

## GENERAL INSTRUCTIONS

The section of the manual beginning with this page is the CONSTRUCTION section. All pages in this section have page numbers followed by "C" (1C, 2C, etc.). The INSTRUCTION section resumes on the pages following the CONSTRUCTION section. Note that the CONSTRUCTION section is located centrally in the book and may be removed without disrupting the INSTRUCTION section that both precedes it and follows it.

Care taken in the construction of this instrument will reward the constructor with many years of satisfactory service and greater confidence in his instrument. We urge you to not rush the construction, but to take all the time necessary for proper assembly and wiring.

Furthermore, we urge strongly that you follow the wire and parts layout shown in the pictorial diagrams as closely as possible. Very often wires are placed as shown for a good reason, and certainly the appearance of the completed instrument will be improved and the difficulty of finding a wiring error will be reduced by the following the wire and parts layout shown.

UNPACKING THE KIT: Unpack the kit carefully and check each part against the parts list including those parts that are mounted to the chassis. If you have trouble identifying any parts refer to the pictorial diagrams or the color code chart.

You will find that the value of a component will vary within the allowable circuit tolerance. For example, the  $4.7K\Omega$ ,  $\pm 10\%$  resistor may measure anywhere between  $4.2K\Omega$  and  $5.2K\Omega$ . Tolerances on paper capacitors are substantially greater, and the tolerance for electrolytics is usually  $\pm 100\%$  and  $-50\%$ .

CONSTRUCTION HINTS: USE THE BEST GRADE OF ROSIN CORE SOLDER ONLY, preferably one containing the new activated fluxes such as Kester "Resin-Five", Ersin "Multicore" or similar types. UNDER NO CIRCUMSTANCES USE ACID CORE SOLDER OR ACID FLUX since acid flux can cause serious corrosion. Before soldering make a certain of a good mechanical connection. Use a clean, freshly tinned soldering iron, no smaller than 100 watts, and place the solder on the joint (not on the iron) so that the solder is melted by the heat from the joint itself. Do not remove the soldering iron until the solder flows and check to see that the resulting joint is smooth and shiny when the solder has cooled. There are two extremes to be avoided; too little heat and too much heat. If too little heat is supplied, the joint will appear pitted and grey, indicating a rosin joint which is unsatisfactory. On the other hand, if too much heat is applied to a joint, the parts connected to it may either change value, lose their protective coating, or break down. If you are sol-

dered with the tip of a pair of longnose pliers. The pliers will conduct the heat away and prevent the component from being unduly overheated. If for any reason it is necessary to resolder a joint, be sure to use new solder.

It should also be noted that the leads on resistors, capacitors, and transformers are often longer than required. These leads should be trimmed to the proper length when necessary. Do not cut any lead until you have determined the required length when the lead is routed as shown in the diagrams.

BASIC TOOLS REQUIRED: These basic tools are required for the construction of the amplifier.

1. Screwdriver -  $3/16"$  to  $1/4"$  blade
2. Screwdriver -  $1/8"$  blade
3. Longnose pliers - 5 or 6"
4. Diagonal cutters
5. Soldering iron (100 watts), or soldergun, or pencil iron (35 watts)
6. Gas pliers
7. High quality rosin or equivalent synthetic flux core solder. Do not use acid or paste flux under any circumstances.

A set of spintites and a wire stripper are also very useful supplementary tools.

PARTS IDENTIFICATION: Please note that very many of the parts for which color coding is given may not be color coded, but have their values and ratings printed. The letter K is a multiplier ( $\times 1000$ ) and on resistors or capacitors indicates that the printed numerical value must be multiplied by one thousand to obtain the value in ohms or micro-micro farads respectively. Note also that one microfarad (mf) is equal to one million; micro-microfarads (mmf). To aid in rapid identification, keep in mind that 5%, 10%, and 20% resistors are color coded whereas 1% resistor have their values printed; also that molded tubular capacitors may or may not be color coded, whereas disc capacitors and electrolytics will always have their values printed. Please note the following relationships between the units used to express resistance or capacity.

1,000,000 ohms ( $\Omega$ ) = 1000 kilohms (K $\Omega$ ) = 1 megohm (M $\Omega$ )  
1,000,000 micro-micro farads (mmf) = 1 micro farads (mf)

CONSTRUCTION PROCEDURE: The complete step-by-step mounting and wiring procedure follows. To keep the drawings uncrowded, unnecessary repetition of mounting or wiring details may be omitted. Note: The abbreviation (C) means connect but do not solder (until other leads have been connected). The abbreviation (S) means connect and solder.

Bend the ground lug tabs on the sockets toward the chassis to prevent accidental shorting to the socket pins.



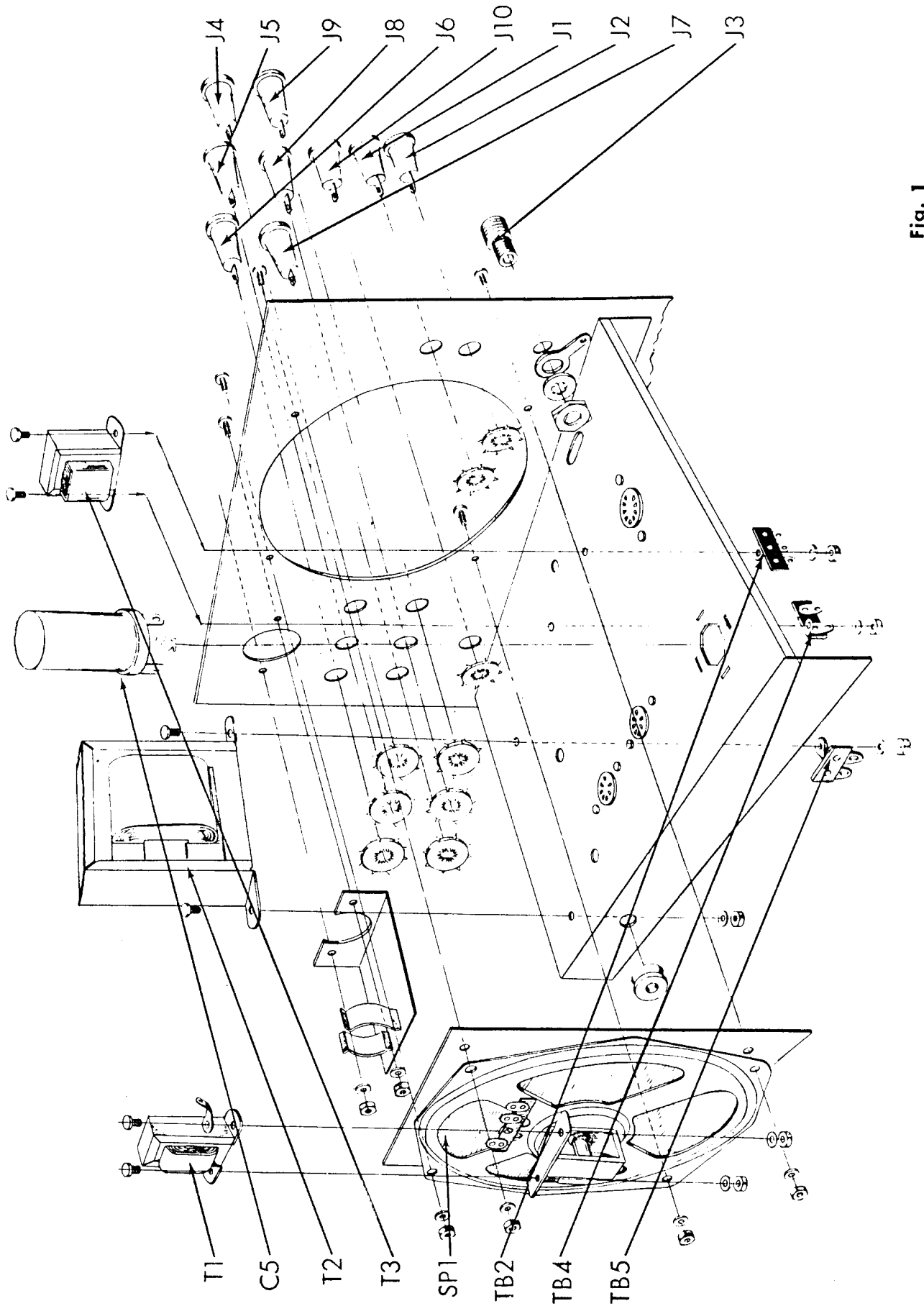

Fig. 1



## PANEL AND TOP OF CHASSIS MOUNTING

1. ( ) Fig. 1. From the front side of the panel, push a red pin jack, J1, through the top of the two holes marked AUDIO INPUT. From the rear side of the panel, force a star washer over the pin jack, with the rounded (convex) side facing away from the panel. Push the star washer over the pin jack until the pin jack is secured against the panel.
2. ( ) Fig. 1. Similar to the above, mount the black pin jack, J2, directly below the red one. In a similar manner, on the left hand side of the panel, mount OUTPUT TRANSFORMER red pin jacks, J4, J5, J6; mount TEST SPKR. GND, TEST AMP, VTVM SCOPE black pin jacks, J7, J8, J9, J10. Use one star washer over each to secure to panel.
3. ( ) Fig. 1. Mount RF input connector, J3, as shown. Use ground lug, 2 lockwashers and nut supplied with connector. Do not use fiber washers supplied with connector.
4. ( ) Fig. 1. Mount the bracket to hold the eye tube as shown. Use two 6-32 screws, two #6 lockwasher and two 6-32 hex nuts. For the convenience of drawing, this socket is shown pushed away from the panel in Fig. 3. As shown in Fig. 3, push the 1629 eye tube V4, gently but firmly, into the bracket with the front of the tube flush against the panel. Push an octal socket over the pins of the tube, noting the key in the center of both tube base and socket. The tube should be turned in its bracket until the key faces directly downward.
5. ( ) Fig. 1. Mount the speaker, SP1, on the front panel using four #6-32 screws, four #6 lockwashers and four #6-32 hex nuts. Between the speaker and the panel, place the speaker grill. The screws holding the speaker must first pass through the holes in the grill.

6. ( ) Fig. 1. Mount the output transformer, T1, to the bracket on top of the speaker. The leads on the transformer face the panel and speaker. Use two #6-32 screws, two #6 lockwashers and two #6-32 hex nuts. Under one of the screws, mount a #6 ground lug as shown.
7. ( ) Fig. 1. On the top of the chassis (not attached to the panel as yet) mount power transformer, T2, as shown. As shown in Fig. 3, the black leads face the side of the chassis and all the other leads face the center of the chassis. Use two #6-32 screws, two #6 lockwashers and two #6 hex nuts. Under one of the lockwashers, mount a 1 post left with ground terminal board, TB5 (under the chassis), as shown in Fig. 4.
8. ( ) Fig. 1. On the top of the chassis mount current transformer, T3, as shown. The red leads go through the hole at the center of the chassis. Use two #6-32 screws, two #6 lockwashers and two #6-32 hex nuts. Under one lockwasher mount a two post with ground terminal boards, TB2; under the other lockwasher mount a one post left with ground terminal board, TB4, as shown in Fig. 4.
9. ( ) Fig. 1. On the top of the chassis mount electrolytic capacitor can C5 as shown. Note the direction (half moon, square and triangle near the lugs) for mounting capacitor in Fig. 4. Insert the mounting tabs into the slots in the chassis and twist the tabs somewhat less than a quarter turn. DO NOT twist the tabs excessively or they will shear off. Solder the tab without a hole to the chassis at its slot.
10. ( ) Fig. 1. Push the 3/8 rubber grommet through hole on rear apron of the chassis.

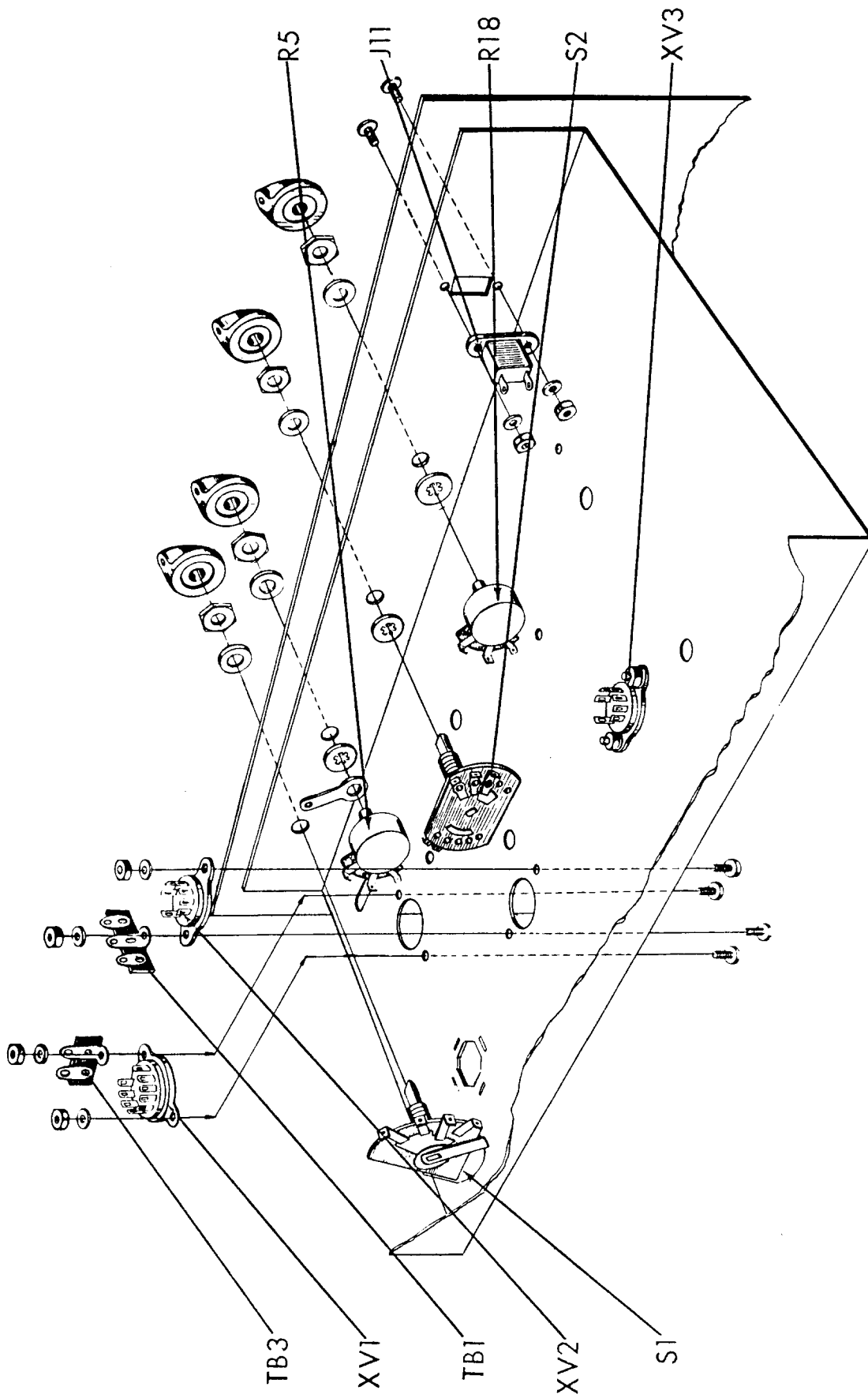

Fig. 2



## BOTTOM OF CHASSIS MOUNTING

1. ( ) Fig. 2. Mount 9 pin miniature tube socket XV1 as shown. Use two #4-40 screws, two #4 lockwashers and two #4-40 hex nuts. Note direction of mounting from figure 4. Under one of the lockwashers, mount a one post left with ground terminal board, TB3, as shown.
2. ( ) Fig. 2. Mount 7 pin miniature tube socket XV2, as shown. Use two #4-40 screws, two #4 lockwashers and two #4-40 hex nuts. Note direction of mounting from figure 4. Under one of the lockwashers mount a two post with ground terminal board, TB1, as shown.
3. ( ) Fig. 2. Mount 7 pin miniature tube socket XV3 as shown. Use two #4-40 screws, two #4 lockwashers and two #4-40 hex nuts. Note direction of mounting from figure 4.

The two pots, two switches and power outlet shown in figure 2 are used to hold the front panel to the chassis. The shafts will extend through the chassis and the corresponding holes in the front panel. In all the following operations the

panel is mounted against the front apron of the chassis. There is no hardware between the chassis and the panel.

4. ( ) Fig. 2. Mount the 500K $\Omega$  gain pot R5 as shown. Inside the chassis, use a pot grounding lug and a 3/8 lockwasher as shown. Outside the chassis (on the panel) use a 3/8 flatwasher and a 3/8 hex nut. The ground lug is eventually to be soldered to R5-1.
5. ( ) Fig. 2. Mount the 50K $\Omega$  wattmeter pot, R18, as shown. Similar to the above (but less a pot ground lug) use a 3/8 lockwasher, one 3/8 flatwasher and one 3/8 hex nut.
6. ( ) Fig. 2. Mount input selector switch S1, (60053) and output selector switch S2, (60054) as shown. Similar to the above, use one 3/8 lockwasher, one 3/8 flat washer and one 3/8 hex nut on each.
7. ( ) Fig. 2. Mount the power socket, J11, as shown. Use two #6-32 x 3/8 screws outside the chassis (on the panel) and two #6 lockwasher and two #6-32 hex nuts inside the chassis.

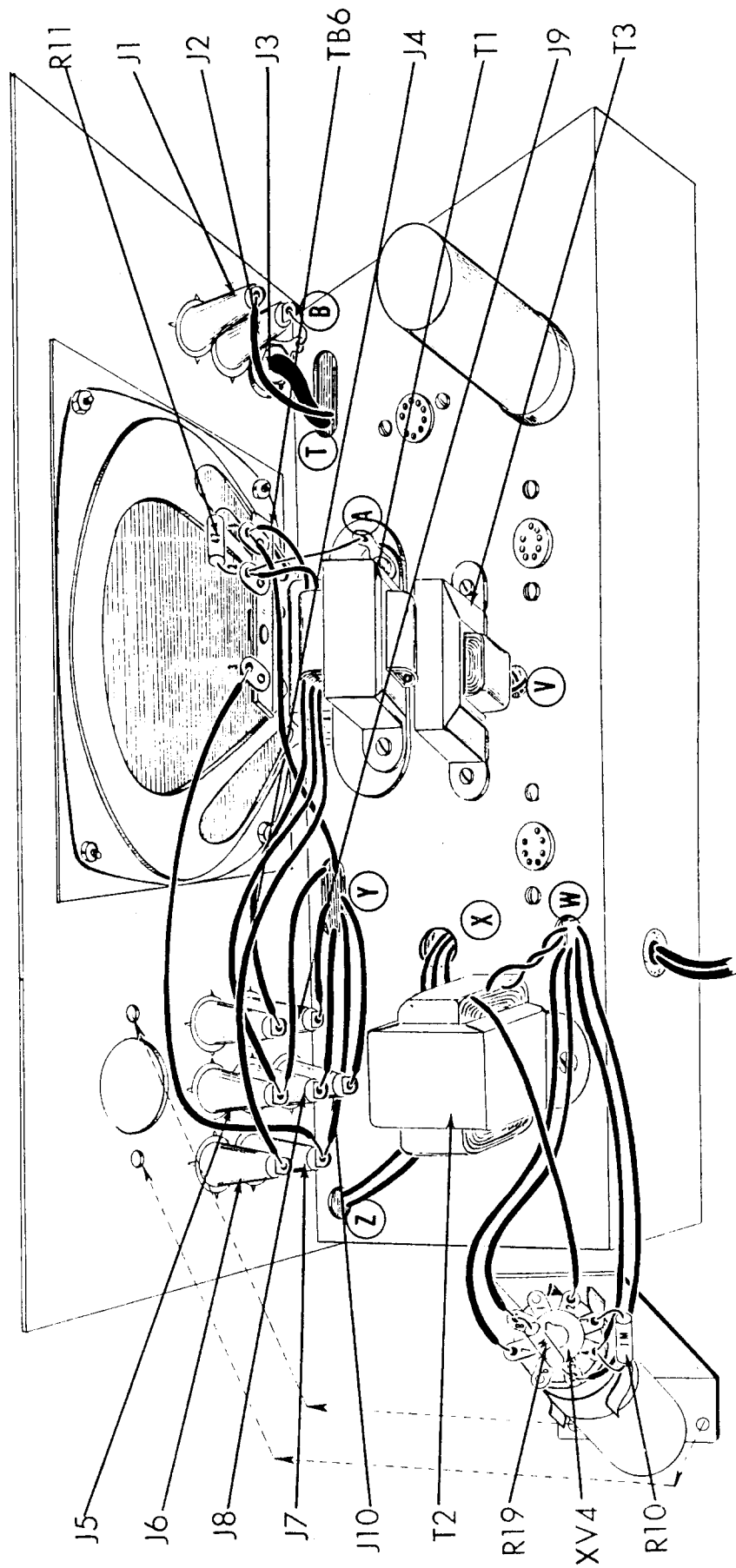

Fig. 3



## TOP CHASSIS WIRING

1. ( ) Fig. 3. On power transformer, T2, cut the upper black lead to 4" and the lower black lead to 7 1/2". Push both leads through hole "Z" in the chassis.
2. ( ) Fig. 3. On power transformer, T2, cut green, green-yellow and brown leads to 3". Connect the brown lead to XV4-2(S) and push the green and green-yellow leads through hole "W" in the chassis.
3. ( ) Fig. 3. On power transformer, T2, cut the two red and the red-yellow lead to 3 1/2". Push these leads through hole "X" in the chassis.
4. ( ) Fig. 3. On wattmeter transformer, T3, cut one red to 3" and the other red lead to 4 1/2". Push both leads through hole "Y" in the chassis.
5. ( ) Fig. 3. On wattmeter transformer, T3, cut one black lead to 3" and the other black lead to 6". Push both leads through hole "U" in the chassis (see fig. 2).
6. ( ) Fig. 3. On output transformer, T1, cut the red and brown leads to 4" and the blue lead to 4 1/2". Connect the brown lead to J4 (C), the red lead to J5 (C) and the blue lead to J6 (S).
7. ( ) Fig. 3. Connect a 2" piece of bare wire from ground lug "A" (S) to TB6-2 (C).
8. ( ) Fig. 3. Cut both enameled leads on output transformer, T1, to 1" and scrape the enamel off both leads for 1/4" from the end. Cover both leads with 3/4" pieces of spaghetti. Connect the lower lead to TB6-2 (C) and the upper lead to TB6-1 (C).
9. ( ) Fig. 3. Cut both leads on the 47Ω (yellow, violet, black, silver) resistor, R11, to 1/2". Connect from TB6-1 (C) to TB6-2 (S).
10. ( ) Fig. 3. Connect one end of an 8" piece of black wire to TB6-1 (S). Push the other end through hole "Y".
11. ( ) Fig. 3. Connect a 6" piece of green wire from TB6-3 (S) to J7 (C).
12. ( ) Fig. 3. Connect one end of a 6" piece of green wire to J7 (S). Push the other end through hole "Y".
13. ( ) Fig. 3. Connect one end of a 5" piece of grey wire to J8 (S). Push the other end through hole "Y".
14. ( ) Fig. 3. Connect one end of a 2 1/2" piece of brown wire to J9 (S). Push the other end through hole "Y".
15. ( ) Fig. 3. Connect one end of a 9" piece of yellow wire to J10 (S). Push the other end through hole "Y".
16. ( ) Fig. 3. Connect one end of a 10" piece of red wire to J5 (S). Push the other end through hole "Y".
17. ( ) Fig. 3. Connect one end of a 10" piece of violet wire to J4 (S). Push the other end through hole "Y".
18. ( ) Fig. 3. Cut all leads on the two 1MΩ (brown, black, green, silver) resistors, R10 and R19 to 1/2". Connect one resistor from XV4-3 (S) to XV4-4 (C), and the other resistor from XV4-5 (C) to XV4-8 (C).
19. ( ) Fig. 3. Cut a brown lead to 6", a black lead to 6", a red lead to 10" and a green lead to 11". Connect one end of the brown lead to XV4-7 (S), one end of the black lead to XV4-8 (S), one end of the red lead to XV4-4 (S) and one end of the green lead to XV4-5 (S). Push the other end of all leads through hole "W".
20. ( ) Fig. 3. Connect a 2" piece of bare wire from J2 (S) to ground lug "B" (S) on J3.
21. ( ) Fig. 3. Connect one end of a 5" piece of violet wire to J1 (S). Push the other end through hole "T".
22. ( ) Fig. 3. Strip back the outer insulation 1/2" on both ends of a 3" piece of shielded wire. Twist the shield strands on both ends. Cut off the strands from one end. Strip back 1/4" the inner insulation on both ends of the wire. Connect the inner conductor, from the end where the shield strands were cut, to J3 (S), by passing the lead through the hole in J3. Be careful that excess solder or inner conductor strands do not short this input to ground either on the outside of the connector or internally. Pass the other end of this wire through hole "T".

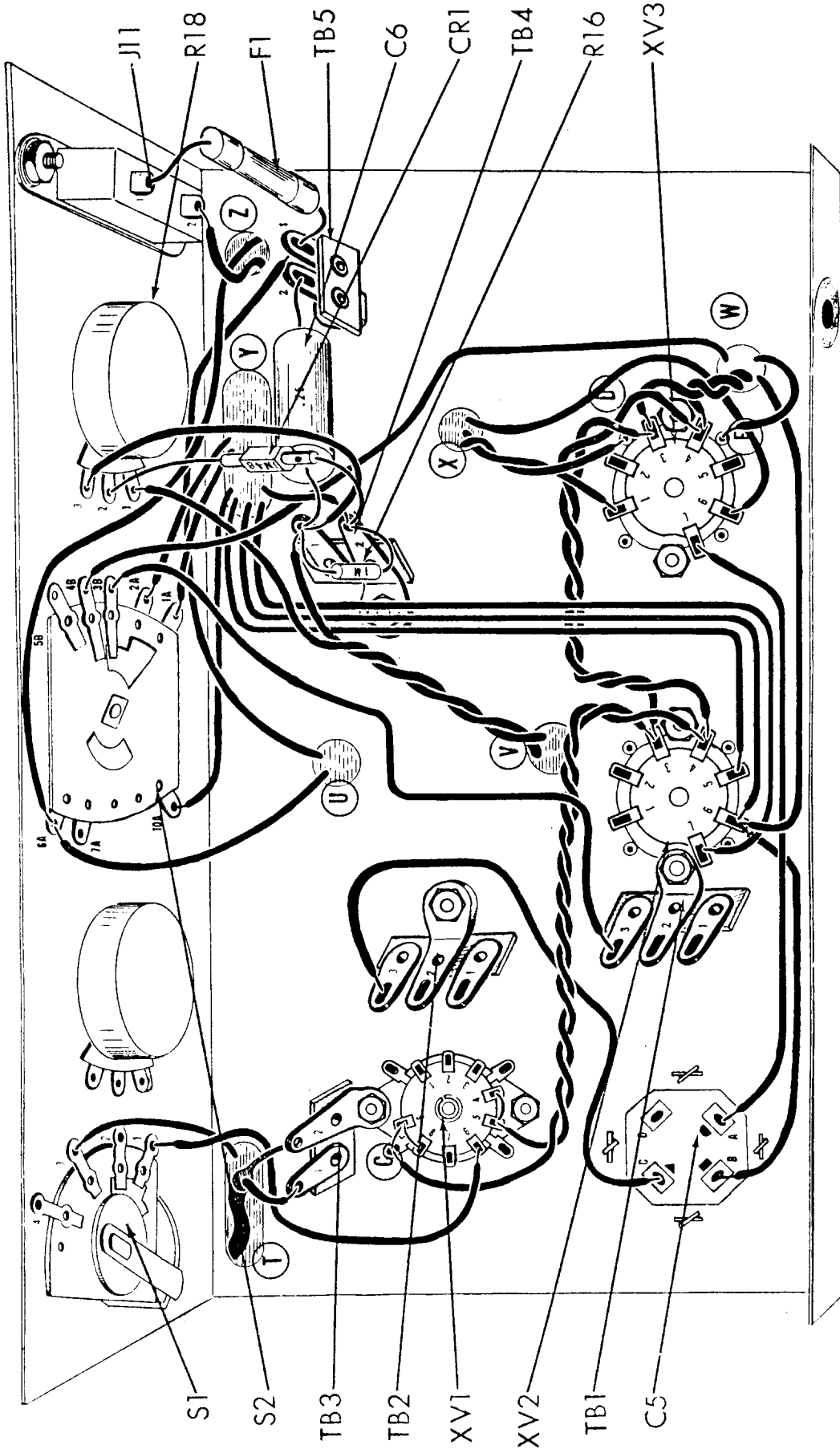

Fig. 4



## BELOW CHASSIS WIRING

1. ( ) Fig. 4. Connect the violet wire from hole "T" to S1-3 (S).
2. ( ) Fig. 4. Connect the longer red lead from hole "X" to XV3-6 (S).
3. ( ) Fig. 4. Connect the green transformer lead from hole "W" to XV3-4 (C) and the green-yellow transformer lead from hole "W" to XV3-3 (C).
4. ( ) Fig. 4. Connect one end of a 4 1/2" piece of brown wire to XV3-3 (S) and one end of a 4 1/2" piece of yellow wire to XV3-4 (C). Twist the leads and connect the other end of the brown wire to XV2-3 (C) and the other end of the yellow wire to XV2-4 (C).
5. ( ) Fig. 4. Connect a 4" piece of red wire from TB2-3 (C) to C5-C (C).
6. ( ) Fig. 4. Connect one end of a 5" piece of brown wire to XV2-3 (S) and one end of a 4" piece of yellow wire to XV2-4 (S). Twist the leads and connect the other end of the brown wire to ground lug "C" (C) on XV1 and the other end of the yellow wire to XV1-5 (C).
7. ( ) Fig. 4. Connect a 1/2" piece of bare wire from XV1-4 (S) to XV1-5 (S).
8. ( ) Fig. 4. Connect a 3/4" piece of bare wire from ground lug "C" (S) to XV1-9 (S).
9. ( ) Fig. 4. Connect a 3 1/2" piece of green wire from S1-1 (S) to XV1-6 (C).
10. ( ) Fig. 4. Connect the outer shield from the cable passing through hole "T" to TB3-2 (S) and the inner conductor to TB3-1 (C).
11. ( ) Fig. 4. Connect the shorter black lead from hole "U" to S2-6A (C) and the longer black lead to TB5-1 (C).
12. ( ) Fig. 4. Connect the shorter black lead from hole "Z" to J11-2 (C) and the longer black lead to S2-6A (C).
13. ( ) Fig. 4. Connect the remaining red lead from hole "X" to XV3-1 (S) and the red-yellow lead to ground lug "D" (S) on XV3.
14. ( ) Fig. 4. Connect the black lead from hole "W" to ground lug "E" (S) on XV3.
15. ( ) Fig. 4. Connect the brown lead from hole "W" to XV3-4 (S).

16. ( ) Fig. 4. Connect the yellow lead from hole "Y" to XV2-7 (C).
17. ( ) Fig. 4. Connect the red lead from hole "Y" to XV2-6 (C).
18. ( ) Fig. 4. Connect the violet lead from hole "Y" to XV2-5 (S).
19. ( ) Fig. 4. Connect the grey lead from hole "Y" to TB4-2 (C).
20. ( ) Fig. 4. Connect the black lead from hole "Y" to S2-1A (S).
21. ( ) Fig. 4. Connect the brown lead from hole "Y" to S2-2A (S).
22. ( ) Fig. 4. Connect the shorter red lead from hole "V" to TB4-1 (C) and the longer red lead to R18-1 (S).
23. ( ) Fig. 4. Connect the red lead from hole "W" to XV2-6 (C).
24. ( ) Fig. 4. Connect the green lead from hole "W" to S2-4B (S).
25. ( ) Fig. 4. Connect a 5 1/2" piece of red wire from XV3-7 (S) to C5A (C).
26. ( ) Fig. 4. Connect a 3 1/2" piece of red wire from XV2-6 (S) to C5B (C).
27. ( ) Fig. 4. Cut both leads on a .25 mfd molded capacitor, C6, to 1". Connect from TB4-1 (C) to TB5-2 (S).
28. ( ) Fig. 4. Cut both leads on the fuse, F1, to 3/4". Connect from J11-1 (S) to TB5-1 (S).
29. ( ) Fig. 4. Cut both leads on diode, CR1, to 3/4". Connect from R18-2 (S) to TB4-2 (C). The plus side (with the dot or other indication) goes towards TB4. Do not overheat or diode will be ruined.
30. ( ) Fig. 4. Connect a 2" piece of violet wire from R18-3 (S) to TB4-1 (C).
31. ( ) Fig. 4. Connect a 7" piece of green wire from S2-3B (S) to TB1-3 (C).
32. ( ) Fig. 4. Cut both leads on a 1MΩ (brown, black, green, silver) resistor, R16, to 1/2". Connect from TB4-1 (C) to TB4-2 (C).
33. ( ) Fig. 4. Connect green wire from hole "Y" to S2-10A (S).



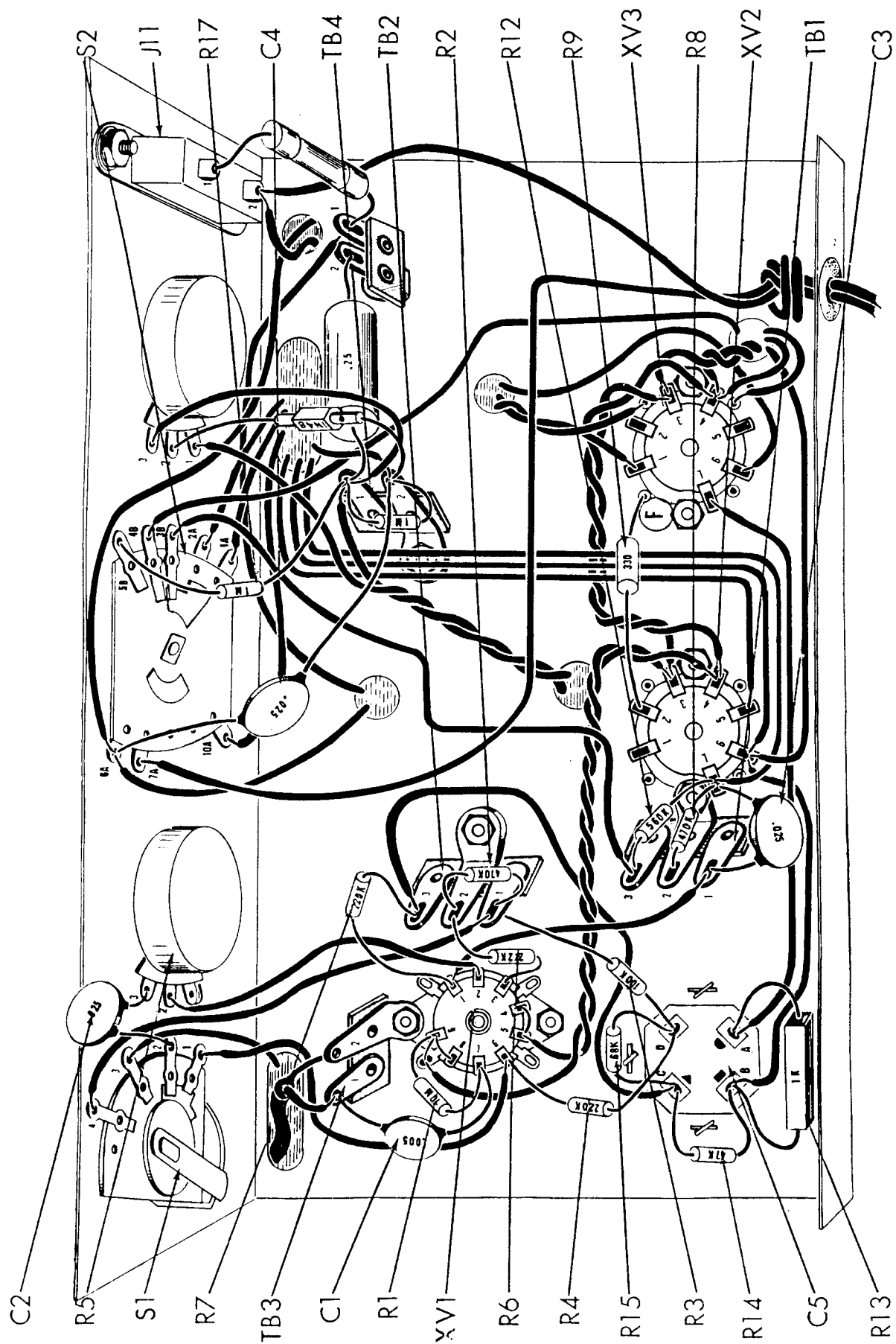

Fig. 5



1. ( ) Fig. 5. Cut both leads on a 1M $\Omega$  (brown, black, green, silver) resistor, R17, to 3/4". Connect from S2-5B (S) to TB4-1 (S).
2. ( ) Fig. 5. Cut both leads on a .025 mfd (25K or 25,000 mmf) disc capacitor, C4, to 1 1/4". Connect from S2-6A (S) to TB4-2 (S). Do not over heat TB4 or diode will be ruined.
3. ( ) Fig. 5. Cut both leads on a 330 $\Omega$  (orange, orange, brown, silver) resistor, R9, to 3/4". Connect from XV2-2 (S) to ground lug "F" on XV3 (S).
4. ( ) Fig. 5. Cut both leads on a 560K $\Omega$  (green, blue, yellow, silver) resistor, R12, to 1/2". Connect from TB1-3 (S) to XV2-7 (C).
5. ( ) Fig. 5. Cut both leads on a 470K $\Omega$  (yellow, violet, yellow, silver) resistor, R8, to 1/2". Connect from TB1-2 (S) to XV2-7 (C).
6. ( ) Fig. 5. Cut both leads on a .025 mfd (25K or 25,000 mmf) disc capacitor, C3, to 1/2". Connect from XV2-7 (S) to TB1-1 (C).
7. ( ) Fig. 5. Connect a 3" piece of green wire from TB1-1 (S) to XV1-1 (C).
8. ( ) Fig. 5. Bend ground lug over pin 1 of R5 and solder lug to this pin.
9. ( ) Fig. 5. Connect a 4" piece of violet wire from S1-4 (S) to TB2-1 (C).
10. ( ) Fig. 5. Connect a 3" piece of green wire from R5-2 (S) to XV1-2 (S).
11. ( ) Fig. 5. Cut both leads on a .025 mfd (25K or 25,000 mmf) disc capacitor, C2, to 3/4". Connect from R5-3 (S) to S1-2 (S).
12. ( ) Fig. 5. Connect a 1/2" piece of bare wire from XV1-8 (S) to XV1-9 (C).
13. ( ) Fig. 5. Cut both leads on a 5000 mmf (5K or .005 mfd) disc capacitor, C1, to 3/4". Connect from TB3-1 (S) to XV1-7 (C).
14. ( ) Fig. 5. Cut both leads on a 10M $\Omega$  (brown, black, blue, silver) resistor, R1, to 1/2". Connect from XV1-9 (S) to XV1-7 (S).
15. ( ) Fig. 5. Cut both leads on a 220K $\Omega$  (red, red, yellow, silver) resistor, R4, to 1". Connect from XV1-6 (S) to C5D (C).
16. ( ) Fig. 5. Cut both leads on a 220K $\Omega$  (red, red, yellow, silver) resistor, R7, to 1/2". Connect from XV1-1 (S) to TB2-3 (S).
17. ( ) Fig. 5. Cut both leads on a 2.2K $\Omega$  (red, red, red, silver) resistor, R6, to 1/2". Connect from XV1-3 (S) to TB2-2 (C).
18. ( ) Fig. 5. Cut both leads on a 470K $\Omega$  (yellow, violet, yellow, silver) resistor, R2, to 1/2". Connect from TB2-2 (S) to TB2-1 (C).
19. ( ) Fig. 5. Cut both leads on a 100K $\Omega$  (brown, black, yellow, silver) resistor, R3, to 3/4". Connect from TB2-1 (S) to C5D (C).
20. ( ) Fig. 5. Cut both leads on a 68K $\Omega$  (blue, grey, orange, silver) resistor, R15, to 1/2". Connect from C5C (C) to C5D (S).
21. ( ) Fig. 5. Cut both leads on a 47K $\Omega$  (yellow, violet, orange, silver) resistor, R14, to 1/2". Connect from C5C (S) to C5B (C).
22. ( ) Fig. 5. Cut both leads on the 1K $\Omega$ , 5W, resistor, R13, to 1". Connect from C5A (S) to C5B (S).
23. ( ) Fig. 5. Push the line cord through the grommet at the rear of the chassis. Make a knot 6" from the tined lead end of the wire, inside the chassis. "Zip" the leads apart for 4". Connect one lead to S2-7A (S) and the other lead to J11-2 (S).

## RF PROBE CONSTRUCTION

First, press fit the probe tip into the rectangular notch at one end of the board as shown in Fig. 6. Then install the 1N48 crystal diode, CR2, on the same side of the board the solder lug is on (Fig. 7) between the probe tip and eyelet 1, cathode to eyelet 1, (cathode side of crystal indicated by band or by direction of rectifier symbol — cathode K anode). To do this, pass the cathode lead of the crystal through eyelet 1 and bend back this lead on the other side of the board when the crystal is positioned properly. Solder the anode lead of the crystal to the flat shank of the probe tip and trim off excess. On the same side of the board, install the 470KΩ resistor, (yellow, violet, yellow, silver) R20, one lead in eyelet 1 and the other lead through eyelet 2. Bend back the leads on the other side of the board to lock the resistor in place, and then trim off excess. Solder eyelet 1 (see Fig. 8). To avoid overheating the crystal diode, hold each crystal diode lead with pliers when soldering the terminal to which the lead is connected. When soldering is completed, lay the terminal board aside.

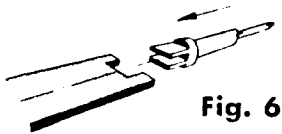

Fig. 6



Fig. 8

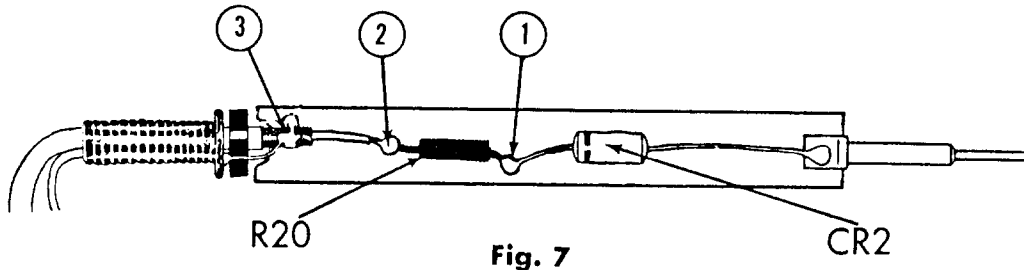

Fig. 7

Strip the grey co-axial cable and the ground lead (stranded wire) as shown in Fig. 9. Position the ground lead in the spring as shown in Fig. 10, and solder it to the spring, as shown, at the point indicated in the drawing. Then insert the co-axial cable in the spring as shown in Fig. 10. Push the rubber washer over the stripped end of the co-axial cable on to the outside insulation and position it as shown in Fig. 7. Next position the stripped end of the co-axial cable so that the end of the outside insulation rests inside the semi-circular notch in the end of the terminal board and the outside braid lays across the solder lug. (Check to see that the inner co-axial conductor reaches eyelet 2.) Then bend the solder lug over to grip the cable braid (Fig. 11 is a profile view) and solder the connection, keeping in mind that overheating will soften the inner co-axial insulation with the consequent danger of a short. Bring the stripped end of the ground lead (extending from the solder point on the spring) around the outside of the rubber washer and insert it in eyelet 3 (Fig. 7, after which solder eyelet 3. Insert the inner conductor of the co-axial cable in eyelet 2 (Fig. 7), after which solder eyelet 2.

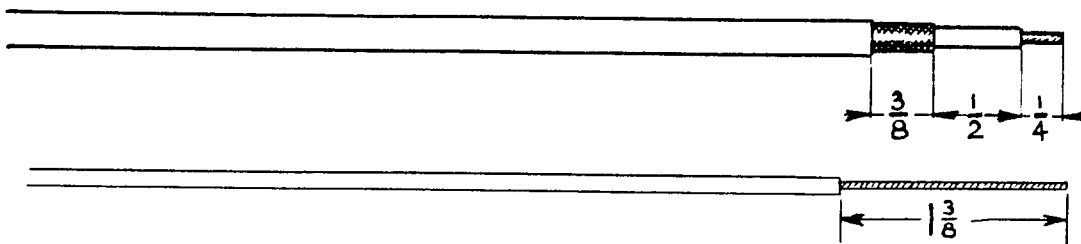

Fig. 9

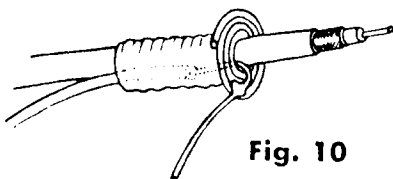

Fig. 10



Fig. 11

Pass the free ends of the co-axial cable and the ground lead through the probe shell from the threaded end. Then grasp the probe tip with one hand and with the other hand move the shell down over the probe body with a rocking motion and without forcing. When the large end of the spring is flush against the rolled over end of the shell, pass the plastic nose-piece over the probe tip and screw it into the shell (see Fig. 12). Complete the ground lead by connecting and soldering and alligator clip to the free end (crimp U-shaped groove in clip over the insulation to make a firm mechanical connection).

Connect the female co-axial connector to the other end of the probe cable as follows (Fig. 13): Strip the cable end exactly as shown. Disassemble the connector. Slip the stripped cable end into the large diameter end of the spring and then solder the small diameter end of the spring to the very edge of the metal braid. Slip the connector ring over the cable end past the spring, unthreaded end first. Pass the cable end thru the tapered end of the connector (threading the inner conductor thru the eyelet in the bakelite disc) until passage is stopped by the large spring diameter. Tighten the set screw in the connector body so that the cable and spring will be secured mechanically. Solder the inner conductor of the cable to the eyelet in the bakelite disc and trim off excess lead. A section of the internally threaded part of the connector ring should extend past the connector body to enable coupling to the male connector on the panel.

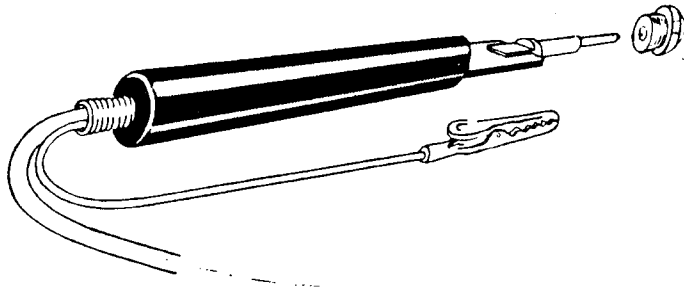

Fig. 12



Fig. 13

## AUDIO PROBE CONSTRUCTION

1. ( ) Fig. 14, end A. Strip one end of the 4 ft. length of black shielded test lead as follows: Remove  $1\frac{3}{4}$ " of the black outside insulation. From the same end, remove  $1\frac{1}{2}$ " of braid. Next, expose  $\frac{3}{4}$ " of inner conductor.

Next, solder a 1 ft. length of flat wire braid to the  $\frac{1}{4}$ " of exposed shielding at end A. Wrap the end of the flat braid a few turns around the shielding before soldering to ensure a lasting connection. Also be careful not to overheat the shielding while soldering, as this will soften the inner co-axial insulation with the consequent danger of a short.

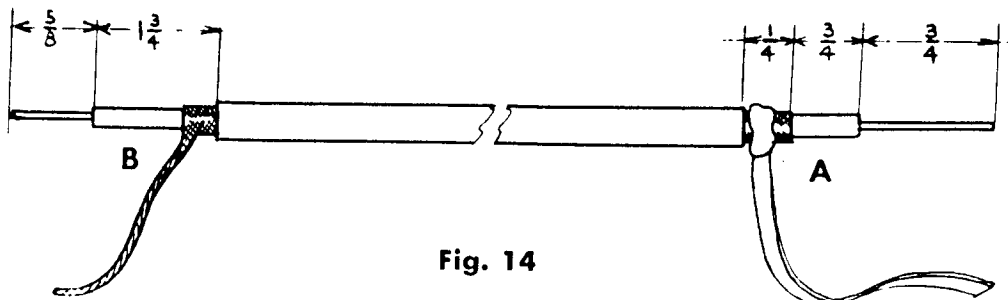

Fig. 14

2. ( ) Fig. 15. Adjust the flat wire braid to a position parallel to the shielded lead and flat against it, the free end of the braid pointing toward the remaining long length of lead. Unscrew the collar from the tip of the red audio probe housing, and slide end A of the shielded lead through the housing until the inner conductor protrudes from the small hole in the tip. Wind the exposed inner conductor around the tip in the clockwise direction and then screw on the collar tightly to secure it. Finally, solder an alligator clip to the free end of the flat wire braid.

3. ( ) Fig. 14, end B. Strip the opposite end of the shielded test lead as follows: Remove  $2\frac{3}{8}$ " of black outside insulation. From the same end, remove  $2\frac{1}{8}$ " of braid. Next, expose  $\frac{5}{8}$ " of inner conductor.

Next, solder a 3 1/2" length of flat wire braid to the 1/4" of exposed shielding at end B. Use the same method described above.

4. ( ) Fig. 16. Complete end B of the shielded lead by soldering pin tips to the inner conductor and to the flat wire braid.

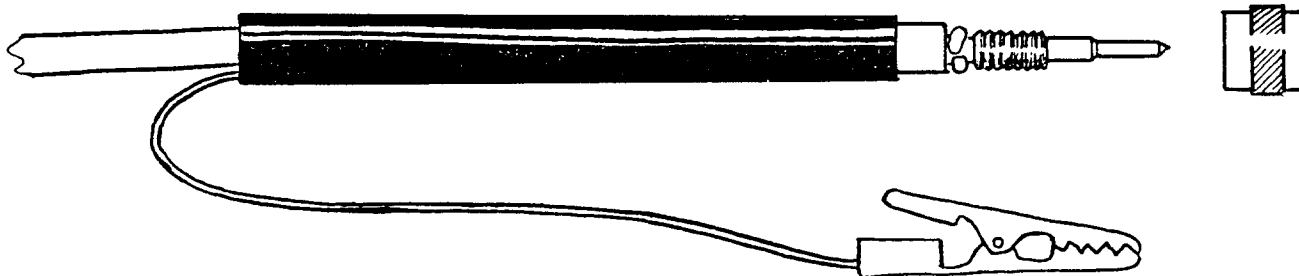

Fig. 15

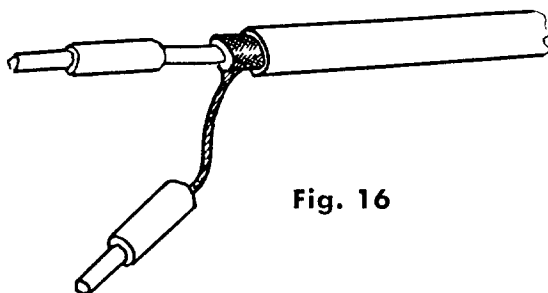

Fig. 16

### FINAL STEPS

You have now completed the assembly and wiring of your instrument. When you have completed the following steps, your instrument will be ready for use.

1) Make a careful examination of the unit to determine whether all joints are soldered properly. Check for loose lumps of solder and straighten out the wiring and components so that there are no accidental short.

2) The flowing of rosin between switch contacts causes leakage. If examination reveals the presence of rosin, remove it by briskly cleaning the area between the contacts with a stiff brush saturated with carbon tetrachloride. Be very careful not to spring the contacts when cleaning switches.

3) Insert the ECC83/12AX7 tube (V1), the 6AQ5 tube (V2), and the 6X4 tube (V3) in their respective sockets on the chassis as shown in Fig. 17.

4) Attach the control knobs as follows:

- a) Turn the shafts of the INPUT SEL. and OUTPUT SEL. switches and the GAIN control and WATTS shafts to their furthest counter-clockwise positions.
- b) Place a knob on the INPUT SEL. switch shaft so that it points at the RF position and tighten the set screw.
- c) Place a knob on the OUTPUT SEL. switch shaft so that it points at the AC OFF position and tighten the set screw.
- d) Place a knob on the GAIN control shaft so that it indicates just to the left of the word GAIN on the panel and tighten the set screw.
- e) Place a knob on the WATTS control shaft so that it points to the zero "0" and tighten the set screw.

5) Before connecting the instrument to the a-c line, connect an ohmmeter from B plus (V3, pin7) to ground; the resistance should not be less than 50,000 ohms. (NOTE: Wait until the ohmmeter reading reaches the final value.) If the resistance is under 50,000 ohms, do not connect to the a-c line before you have checked the rectifier circuit and remedied the trouble.

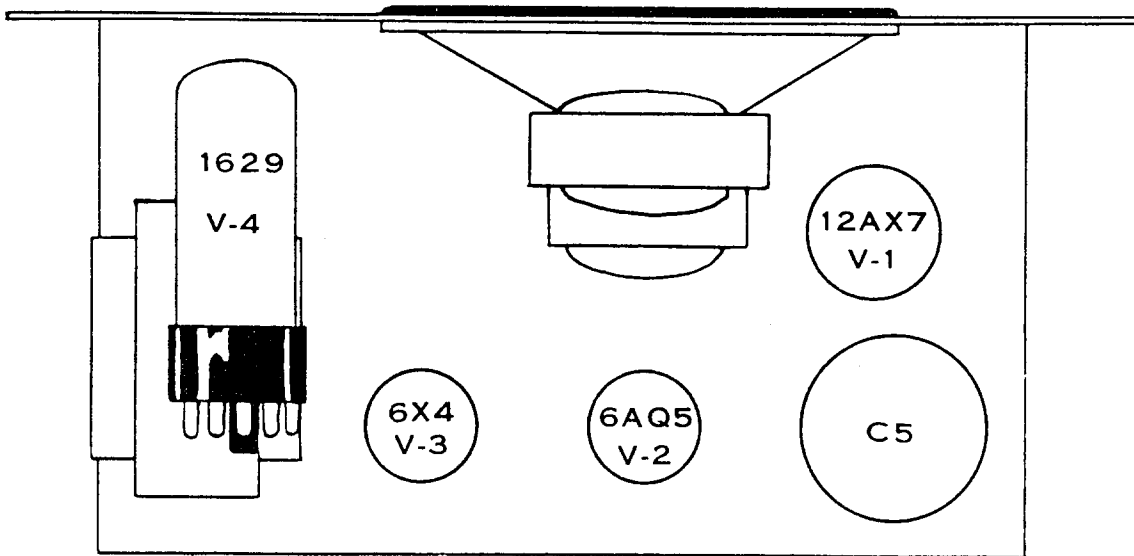

Fig. 17

6) Insert the rubber feet in the openings provided in the bottom of the cabinet as shown. The method is to work the rounded portion of each foot into the interior of the cabinet from the outside, using a small screwdriver. The flat portion should be the actual resting or contact surface. See insert drawing of Fig. 18.

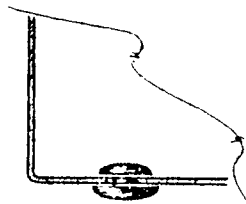

Fig. 18

7) Mount the handle on the cabinet with 2 #10-24 screws as shown in Fig. 19.

8) Run the a-c line cord through the rear cabinet opening and insert the completed unit in the cabinet. Align the hole in the cabinet rear and the hole in the rear chassis apron and insert 1 #6 P.K. screw. Then align the 8 panel holes with the corresponding holes in the cabinet flange and insert 8 #6 P.K. screws. Tighten all screws. (See Fig. 19.)

9) Insert the line cord plug into a 115 VAC outlet and set the Output Selector at TRACE and the Input Selector at RF. Connect both the RF and Audio probes to their proper panel connectors. The eye tube should show its characteristic green glow within a minute. (If not, check the power supply and/or the eye tube circuit.)

Now turn the GAIN control clockwise to near maximum. Touching the tip of the RF probe should result in a loud humming sound from the signal tracer speaker as well as a closing of the shadow angle on the eye tube. Touching the tip of the audio probe should produce a much lower output buzzing or humming sound and a reduced closure of the eye tube shadow angle. If these results are not obtained the instrument is not functioning properly and should be checked for the cause.

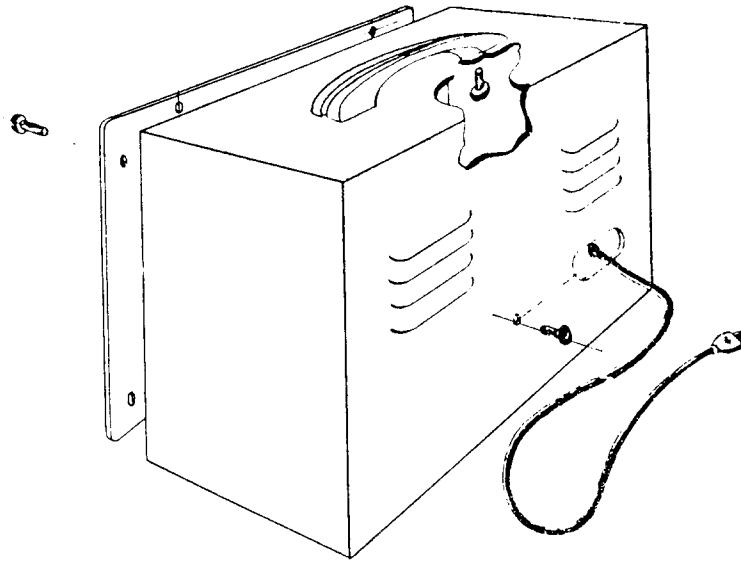

**Fig. 19**

**NOTE**

If the instrument fails to operate properly, recheck the wiring for errors or reversed connections, test for continuity, and check individual components for breakdown. Check all dc and ac operating voltages, keeping in mind that all voltages may vary from the values shown by as much as 20% due to component tolerance, line voltage variations, and the type of measuring instrument used (schematic voltages were measured with VTVM).

**SERVICE**

If you are still having difficulty, write to our service department listing all possible indications that might be helpful. If desired, you may return the instrument to our factory where it will be placed in operating condition for \$5.00 plus the cost of parts replaced due to their being damaged in the course of construction. This service policy applies only to completed instruments constructed in accordance with the instructions as stated in the manual. Instruments that are not completed or instruments that are modified will not be accepted for repair. Instruments that show evidence of acid core solder or paste fluxes will be returned not repaired. NOTE: Before returning this unit, be sure all parts are securely mounted. Attach a tag to the instrument, giving your home address and the trouble with the unit. Pack very carefully in a rugged container, preferably wood, using sufficient packing material (cotton, shredded newspaper, or excelsior), to make the unit completely immovable within the container. The original shipping carton is satisfactory, providing the original inserts are used or sufficient packing material is inserted to keep the instrument immovable. Ship by prepaid Railway Express, if possible, to the Electronic Instrument Co., Inc., 33-00 Northern Blvd., Long Island City 1, New York. Return shipment will be made by express collect. Note that a carrier cannot be held liable for damages in transit if packing, IN HIS OPINION, is insufficient.

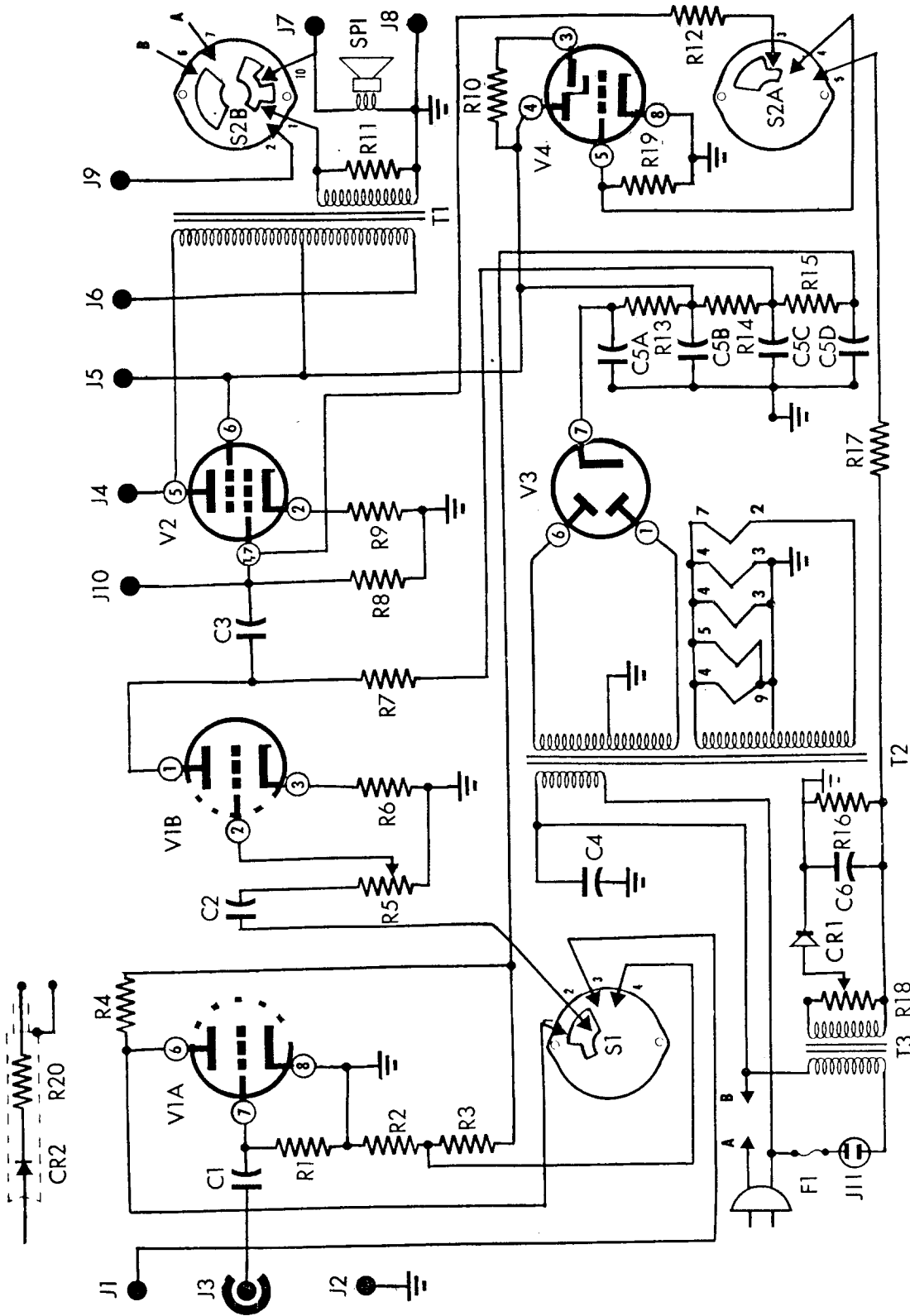

Sym.	Description	Sym.	Description	Sym.	Description	Sym.	Description
C1	cap., disc., .005 mfd, 10%	J9	Test Ampl.	R7	res., 220KΩ, 1/2W, ±10%	SPI	speaker
C2	cap., disc., .025 mfd, 10%	J10	VTVM Scope	R8	res., 470KΩ, 1/2W, ±10%	T1	output transformer
C3	cap., disc., .025 mfd, 10%	J11	Wattmeter	R9	res., 330Ω, 1W, ±10%	T2	power transformer
C4	cap., disc., .025 mfd, 10%	R1	res., 10MΩ, 1/2W, ±10%	R10	res., 1MΩ, 1/2W, ±10%	T3	current transformer
C5	cap., elec., 2 x 20/350V	R2	res., 470KΩ, 1/2W, ±10%	R11	res., 47Ω, 1/2W, ±10%	V1	6 tube, 12AX7
C6	cap., molded, .25 mfd -400V	R3	res., 100KΩ, 1/2W, ±10%	R12	res., 470KΩ, 1/2W, ±10%	V2	tube, 6AQ5
CR1	rectifier, 1N48	R4	res., 220KΩ, 1/2W, ±10%	R13	res., 1KΩ, 5W, ±10%	V3	tube, 6X4
CR2	rectifier, 1N48	R5	pot., 500KΩ audio taper	R14	res., 47KΩ, 1/2W, ±10%	V4	tube, 1629
F1	fuse, 5A, 16-blo	R6	res., 2.2KΩ, 1/2W, ±10%	R15	res., 68KΩ, 1/2W, ±10%		
J1	AF Input			R16	res., 1MΩ, 1/2W, ±10%		
J2	Ground			R17	res., 1MΩ, 1/2W, ±10%		
J3	RF Input			R18	pot., 50KΩ, linear		
J4	Plate (output transformer)			R19	res., 1MΩ, 1/2W, ±10%		
J5	B+ (output transformer)			R20	res., 470KΩ, 1/2W, ±10%		
J6	Plate (output transformer)			S1	Input Selector		
J7	Test Speaker			S2	Output Selector		
J8	Ground						



MODEL 147 A SIGNAL TRACER





## CAPACITOR COLOR CODES

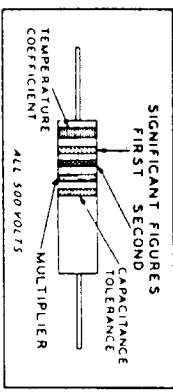
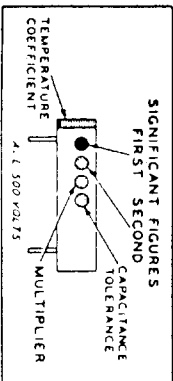
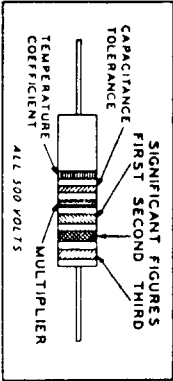
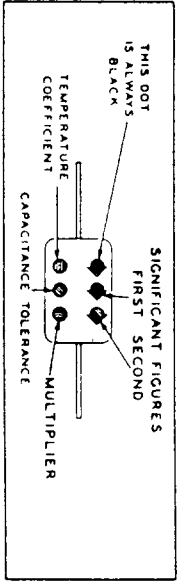
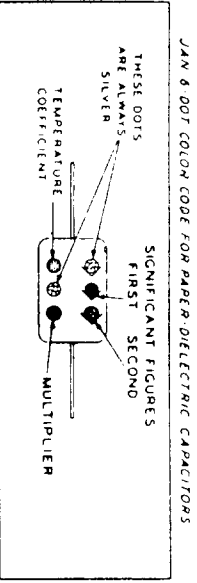
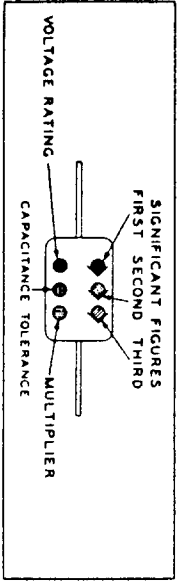
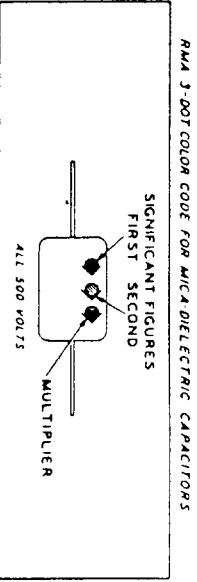

## RESISTOR COLOR CODES

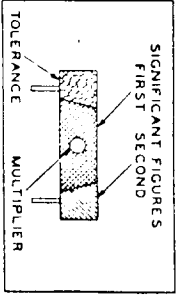
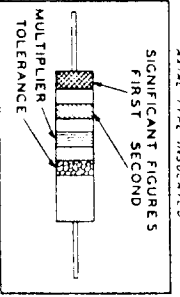
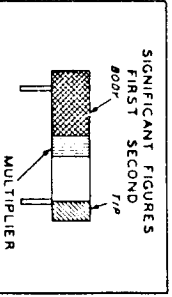
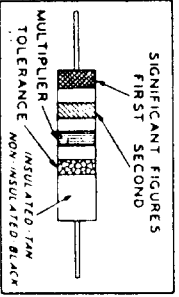

RESISTORS		CAPACITORS				VOLTAGE RATING	TEMPERATURE COEFFICIENT
TOLERANCE	MULTIPLIER	SIGNIFICANT FIGURE	COLOR	RMA MICA AND CERAMIC-DIELECTRIC	JAN MICA AND PAPER-DIELECTRIC		
1	1	0	BLACK	1	1	1	A
10	10	1	BROWN	10	10	10	B
100	100	2	RED	100	100	100	C
1000	1000	3	ORANGE	1000	1000	1000	D
10000	10000	4	YELLOW	10000	10000	10000	E
100000	100000	5	GREEN	100000	100000	100000	F
1000000	1000000	6	BLUE	1000000	1000000	1000000	G
10000000	10000000	7	VIOLET	10000000	10000000	10000000	
100000000	100000000	8	GRAY	100000000	100000000	100000000	
1000000000	1000000000	9	WHITE	1000000000	1000000000	1000000000	
5	0.1		GOLD	0.1	0.1	0.1	
10	0.01		SILVER	0.01	0.01	0.01	
20			NO COLOR				

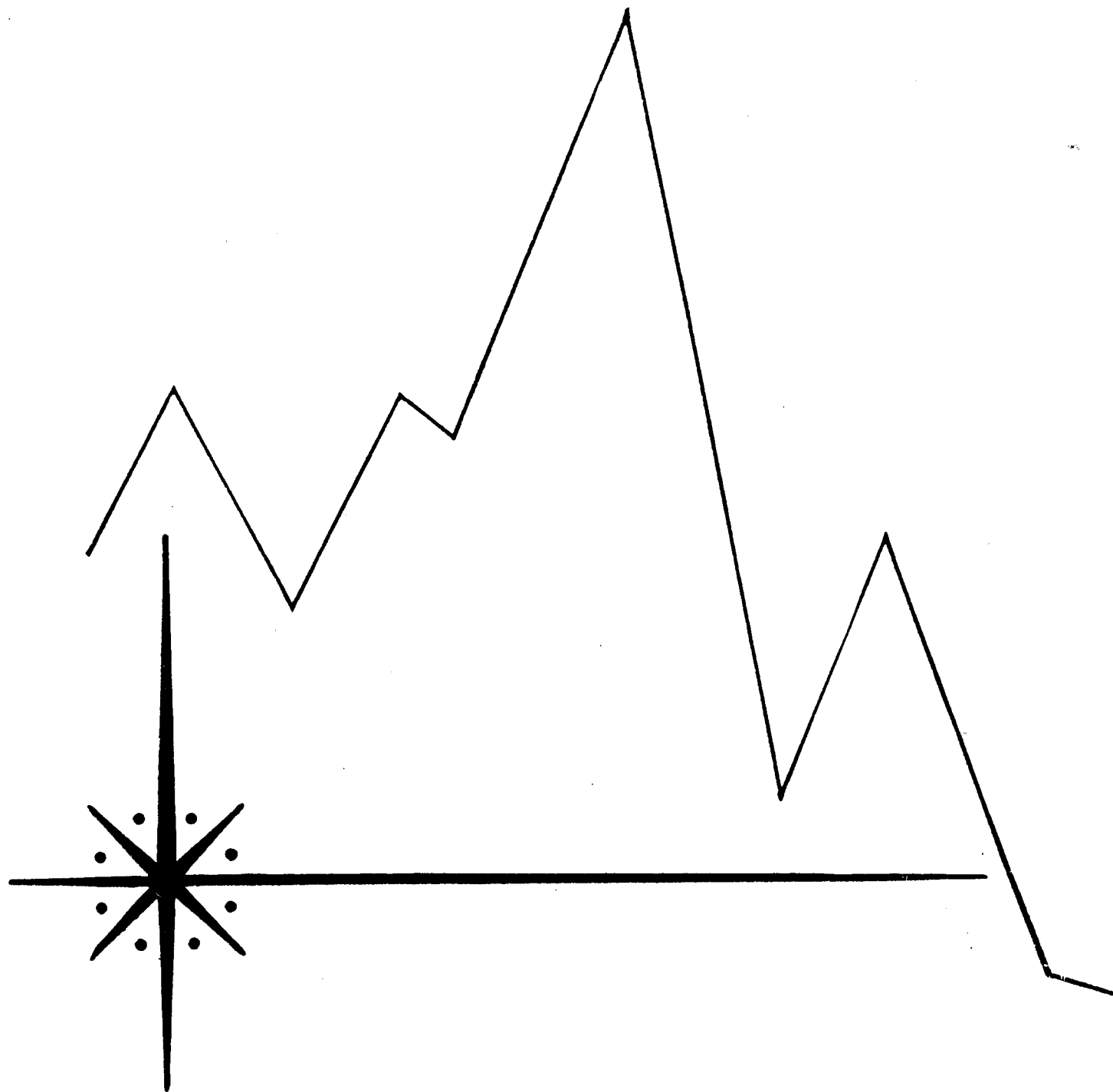

**EICO**

ANOTHER PERFORMANCE PROVEN PRODUCT

# **K4XL's** **BAMA**

This manual is provided **FREE OF CHARGE** from the “BoatAnchor Manual Archive” as a service to the Boatanchor community.

It was uploaded by someone who wanted to help you repair and maintain your equipment.

If you paid anyone other than BAMA for this manual, you paid someone who is making a profit from the free labor of others without asking their permission.

You may pass on copies of this manual to anyone who needs it. But do it without charge.

Thousands of files are available without charge from BAMA. Visit us at <http://bama.sbc.edu>